



"Baby Will"

Valve Junior Conversion Build Manual

1. Introduction

This manual contains instructions to convert an Epiphone Valve Junior guitar amplifier to a roaring 18Watt amp modeled after the famed Marshall 1974X circuit. The heart of it all is the “Baby Will”, a simplified version of Marshall’s 1974X amp known as the Litellb. The Baby Will takes the Litellb circuit and conveniently lays it out in a printed circuit board, PCB, package.

This manual provides instruction for the assembly of versions 1.1 and 1.3 of the Baby Will circuit board. Several of the pictures or diagrams in this manual may refer to or display a previous version of the circuit board i.e., version 1.1. However, these still apply to the current version. Additional explanation is provided to distinguish between the various versions in the relevant sections of this manual.

To simplify things,

- The Epiphone Valve Junior will be referred to as EVJ, and
- The “Baby Will” 18 Watt Litellb PCB will be referred to as the Baby Will.

This manual guides you through the conversion which includes:

- removing the stock EVJ chassis from its cabinet,
- extracting the stock EVJ pcb,
- assembling the Baby Will,
- installation and hookup of the Baby Will into the EVJ chassis,
- initial power-up and testing, and
- reinstalling the chassis back into the EVJ cabinet to finish up the job.



2. Electrical Shock Warning

Building tube amplifiers involves working with, or around, high voltages. Working inside a tube amplifier can be dangerous if you don't know the basic safety practices. Building, modifying, or repairing tube amplifiers should only be performed by trained personnel.



3. Disclaimer of Liability

GuitarAmplifierPCBs.com assumes no liability or responsibility, under any circumstance, for personal injury or damage to property or personal property.

GuitarAmplifierPCBs.com reserves the right to make design changes or improvements without obligation to revise prior versions.

All specifications are subject to change without notice.

Table of Contents

1.	Introduction.....	2
2.	Electrical Shock Warning.....	4
3.	Disclaimer of Liability.....	4
4.	Project Overview.....	7
4.1	Here's what you'll need:.....	7
4.1.1	Parts:.....	7
4.1.2	Tools:.....	7
4.1.3	Supplies:.....	7
5.	Let's get started.....	8
5.1	Remove the EVJ chassis.....	8
5.2	Remove the EVJ's Stock Components.....	9
5.2.1	Remove the Tubes and Tube Retainers.....	9
5.2.2	Remove the Output Transformer.....	9
5.2.3	Clean Up the Power Transformer.....	11
5.2.4	Remove the Volume Potentiometer.....	12
5.2.5	Remove the Stock EVJ Circuit Board.....	12
6.	Prepare the Chassis.....	14
6.1	Layout and Drill.....	14
6.1.1	Layout the Drill Plans.....	14
6.1.2	Drilling the Chassis.....	15
7.	The Baby Will.....	16
7.1	Assemble the Baby Will Circuit Board.....	16
7.1.1	Tube Sockets.....	16
7.1.2	Spade Connectors.....	17
7.1.3	PCB Standoffs.....	17
7.1.4	The Power Grid.....	17
7.1.5	Signal Path and Cathode Resistors.....	19
7.1.6	Signal Path and Cathode Capacitors.....	19
7.1.7	Hum Balance Options.....	20
7.1.8	Filter Capacitors and Ground Wire.....	23
7.1.9	Input Jack and 1Meg Resistor (for Version 1.1).....	23
7.1.10	Input Jack and 1Meg Resistor (for Version 1.3).....	25
7.1.11	Volume and Tone Controls.....	28
8.	Putting it All Together.....	29
8.1	Install the New Components.....	29
8.1.1	The New Output Transformer.....	29
8.1.2	The Baby Will PCB and Tube Hardware.....	31
8.1.3	Hookup the Leads to the Baby Will.....	32
9.	Turn on the Power.....	34
9.1	Check Your Work.....	34
9.1.1	Take a Break.....	34
9.1.2	Visual Inspection.....	34

9.2	Power Up without Tubes	35
9.2.1	The First Power Up.....	35
9.3	Power Up with Tubes.....	37
9.3.1	The Real Test	37
10.	Dial Out the Buzz.....	39
10.1	Adjusting the Hum Balance Potentiometer.....	39
10.1.1	Procedure (for Verion 1.1).....	39
10.1.2	Procedure (for Verion 1.3).....	40
11.	Finish Things Up.....	41
11.1	Re-Assemble the Amp	41
Congratulations! Your Valve Junior is complete. Plug in a guitar and enjoy the legendary tone of your 18 Watt Litellb “Baby Will” guitar amplifier.....		41

4. Project Overview

You'll find that this is a fun project that can be completed by an inexperienced builder in a day or two. We at GuitarAmplifierPCBs.com wrote this manual specifically for the novice builder. So, anyone can do it. Really, it's simple and it doesn't require expensive tools or complex equipment.

4.1 Here's what you'll need:

4.1.1 Parts:

- The "Baby Will" circuit board
- Misc. parts and components (refer to the VJ Conversion parts list document for a full listing of what parts are needed and where you can buy them)

4.1.2 Tools:

- Phillips head screw driver
- Standard screw driver
- Needle nose pliers
- Adjustable wrench
- Power drill (corded or cordless)
- 1/8, 5/16, 3/8 in. Metal cutting drill bits
- Unibit or punch (you'll need something to make two 7/8 in. holes)
- Soldering iron (15-40 watt power rating)

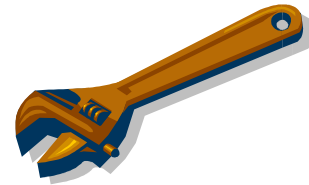

4.1.3 Supplies:

- Fluxed solder
- Roughly 3 ft. 600v rated wire (22-18 AWG)
- 1/4" – 32 Spade connectors (you'll need at least three)
- Tag strip

5. *Let's get started...*

OK. So you have all the parts and are ready to start. Let's get that EVJ chassis out of the cabinet.

5.1 Remove the EVJ chassis

Take off the back panel by removing the seven (7) screws using a Phillips head screw driver.



Be careful pulling off the back panel. They are typically stuck onto the chassis. Slowly pull from each side to prevent the tolex from lifting off the panel.



Locate the screw caps on the top of the EVJ. Using a standard screw driver, the smaller the better, pry up the caps until you can pull them out of their sockets.



Remove the four chassis screws and pull out the chassis.



5.2 Remove the EVJ's Stock Components

A few of the stock EVJ parts have to be replaced. The tubes, tube retainers, stock circuit board, and output transformer need to be removed.

5.2.1 *Remove the Tubes and Tube Retainers*

It's as simple as:

- lift the tube retainer off the power tube,
- turn the retainer shield until the spring lifts the shield off the per-amp tube,
- pull the tubes out, and
- unclip the power tube retainer.

These items can be discarded. They will not be used later in the build.

Now that the tubes and their hardware have been removed we can take a look inside. This is a version 2 EVJ. You can tell by the green board and the rectified DC heater supply. Version 3s have a black board.



5.2.2 *Remove the Output Transformer*

To remove the output transformer, disconnect its wire leads from the main amp circuit board and the output jack circuit board.



You don't need to label the leads since this output transformer won't be used later in the build. However, it's recommended to label them just in case you want to use it in another build at a later time.

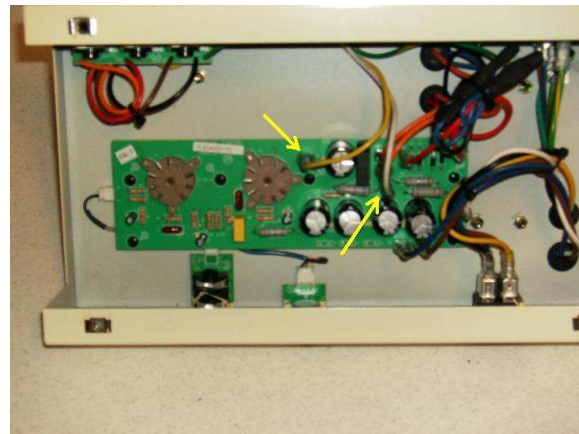

Pull these two spade connectors from the main circuit board.

Unscrew the output jacks from the chassis and separate the board from the chassis.



The board will be glued to the chassis. It may require some extra work to pick the glue off. Be careful not to damage the board or the output jacks. They will be reused later.



Flow the solder to each transformer lead on the output jack board and pull the lead out.

Remove the fastening nut at the star grounding post and remove the output board's ground wire.

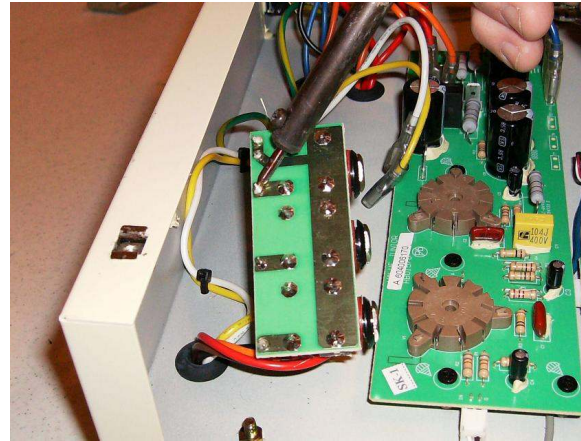

Clean up any remaining solder off the board to assist in the installation of the new transformer later in the build.



Now that all of the leads are free, remove the mounting screws to separate the transformer from the chassis.

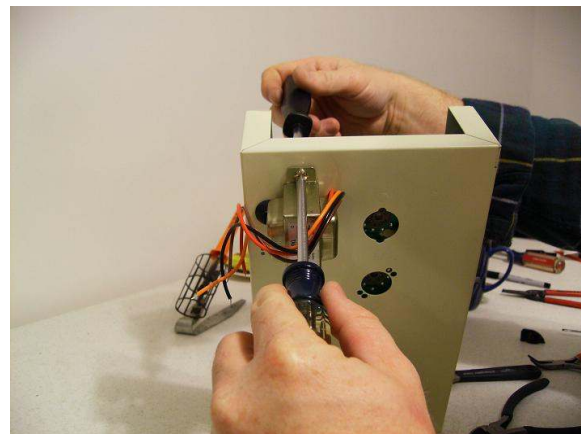

Here's the output board and the output transformer after removal. Set the output board aside. It will be used later in the build.

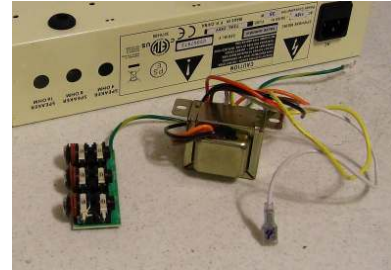

The output transformer can be discarded. It will NOT be used later in the build.

5.2.3 Clean Up the Power Transformer

The stock EVJ's power transformer provides leads for various mains supply voltages. The extra leads are fastened to dead posts on the stock circuit board for storage. We are going to clean up the inside of the chassis by pulling any unused power transformer leads outside of the chassis cavity.

Disconnect these three (3) leads from the stock EVJ circuit board.



Version 1 and 2 EVJ will have 12v secondary taps tied off and tucked inside the chassis. These need to be pulled outside and secured as well.

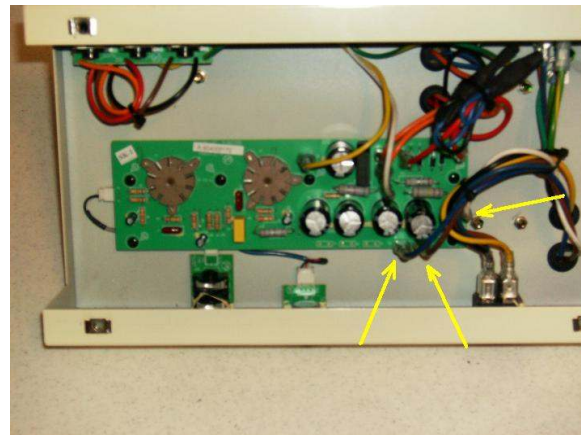

After the leads are all pulled outside the chassis, bundle them together and tie them off.

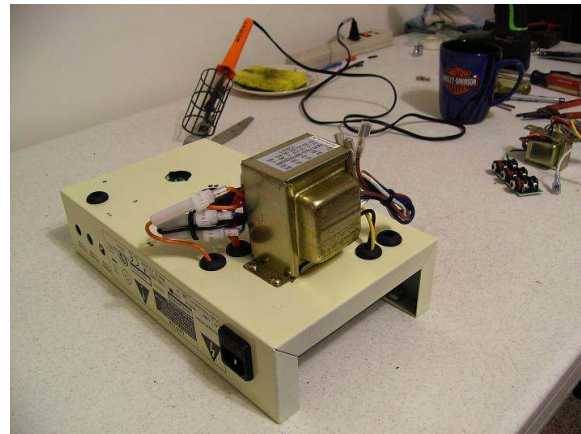

5.2.4 Remove the Volume Potentiometer

Unscrew the fastening nut from the volume potentiometer.

Pull the volume pot back into the chassis. Leave it connected to the stock EVJ circuit board.



The volume pot will be glued to the chassis. This part will NOT be used later in the build, so use whatever force you need.



5.2.5 Remove the Stock EVJ Circuit Board

Disconnect these four (4) leads from the stock EVJ circuit board.

Lift the ground wire from the star ground post.

Unplug the input jack wire at the circuit board.

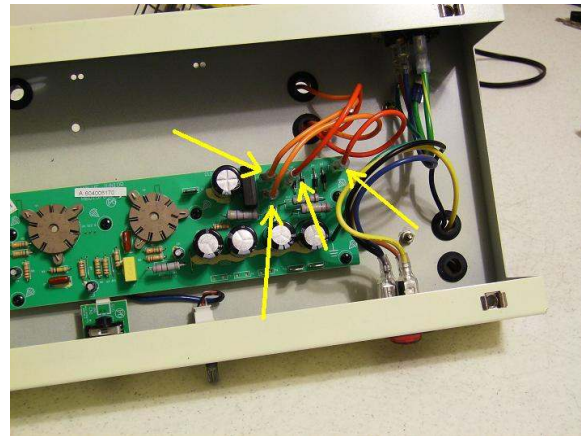

Remove the six (6) screws fastening the circuit board to the chassis.



Remove the stock circuit board and pull all of the power transformer leads to the rim of the chassis.

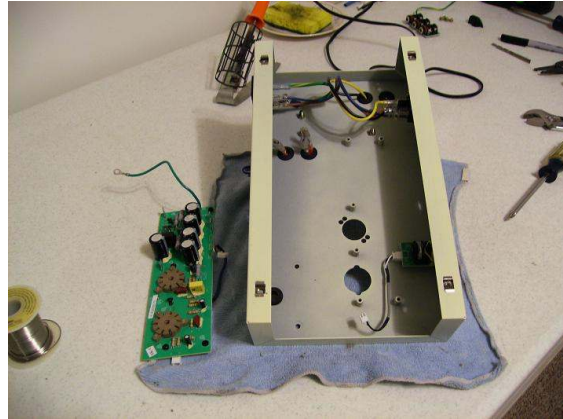

Salvage the ground wire from the stock circuit board for use later.

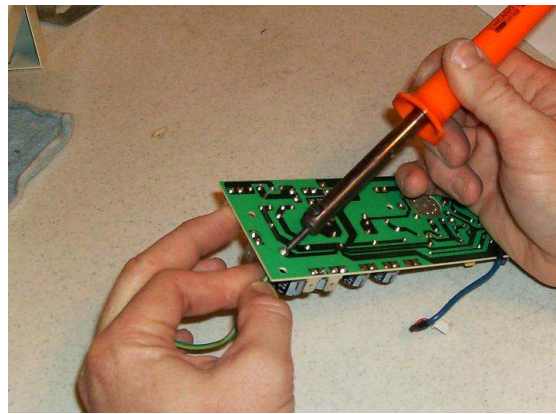

Unscrew the input jack and remove it from the chassis. Set it aside for use later.

6. Prepare the Chassis

6.1 Layout and Drill

The Baby Will circuit board, tone potentiometer, and the new output transformer require some drilling in the chassis.

6.1.1 Layout the Drill Plans



Always verify you are using the latest version of the drill plan posted on GuitarAmplifierPCBs.com.

If you can not print onto 11x17" paper, you can take an electronic version of the drill plan to Kinkos. They will print it professionally for under \$1.

Print out a copy of the VJ Conversion Drill Plan. Make sure it is printed to scale.

Cut away the unused portion of the drill plan as shown. The mounting hole near the back of the power transformer is optional. It's very close to the rubber grommet. It's not used in the picture shown.

Align the drill plan to the chassis using the alignment holes indicated on the plan.

Affix the plan to the chassis with a generous amount of tape.

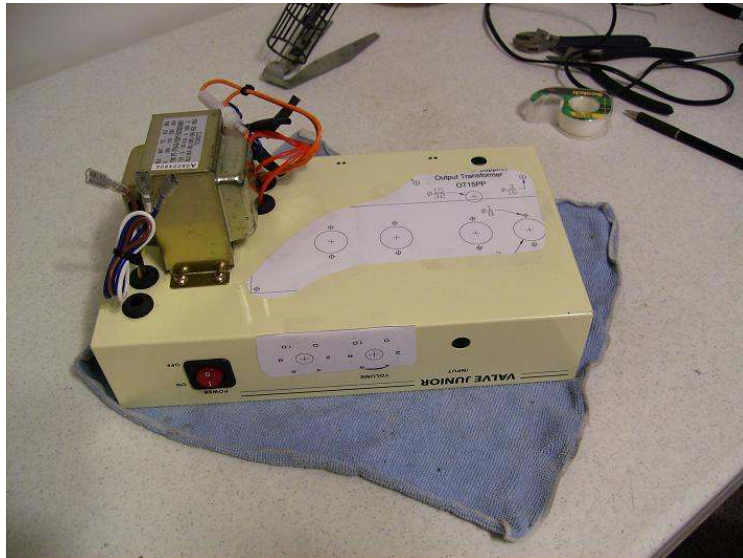

6.1.2 *Drilling the Chassis*

Start by setting the center of each hole to be drilled. A center punch is often used. Here, a 1/16" drill bit was used as shown in the picture.

Use the appropriate drill bit size as prescribed by the drill plan.



Here, a unibit was used to drill out the 7/8" hole for the two (2) additional tube socket holes.

Deburr or countersink each hole to ensure no sharp edges will cause injury or component failure.



Drill out and remove the stock standoffs that are press-fit into the chassis.

7. *The Baby Will*

7.1 Assemble the Baby Will Circuit Board

The anticipation has been killing you, hasn't it? Finally, the assembly of the Baby Will begins.

Did you check you make sure you have all of the parts you'll need to complete the assembly?

I wish I did.



7.1.1 *Tube Sockets*

The tube sockets get installed on the back side of the board.

I repeat the back side of the board.

Insert the tube sockets as shown. They only go in one way (on the back side).

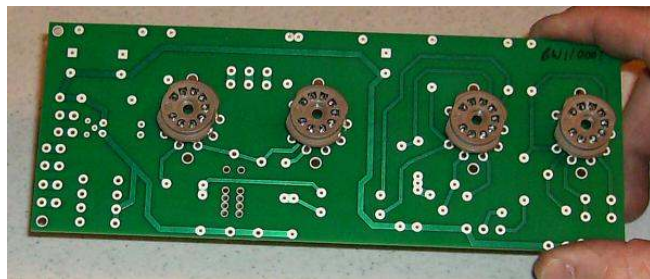

Flip the board over and rest the sockets against your work bench/table. A piece of cardboard is useful to hold the sockets in place when flipping the board over. Slip the cardboard away when it's resting on the bench. Check to make sure each socket is properly seated. Then solder each leg of the sockets. The holes are through plated so the solder will flow into the hole and through to the other side of the socket leg creating a very durable connection.

7.1.2 Spade Connectors

Insert and solder each spade connector one at a time. Work in one direction, because access will be difficult once they are all installed.

Extra solder time is necessary to heat the spade connector before solder will flow. Hold the iron on the connector. Feed the solder when the joint is hot enough to flow. Straighten the connectors as the solder joint sets, or hardens.

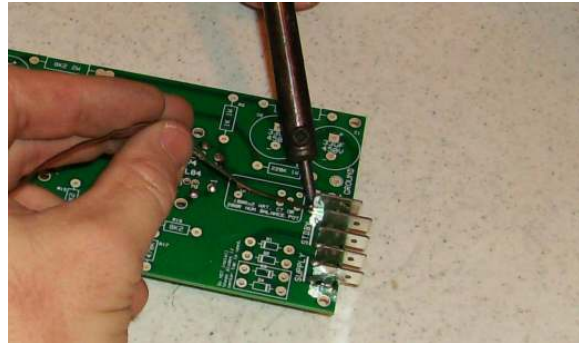

7.1.3 PCB Standoffs

Install the ten (10) PCB standoffs on the back side of the board.

Make sure the standoffs do not contact a tube pin or a solder ball formed on the pin. This will cause a short.

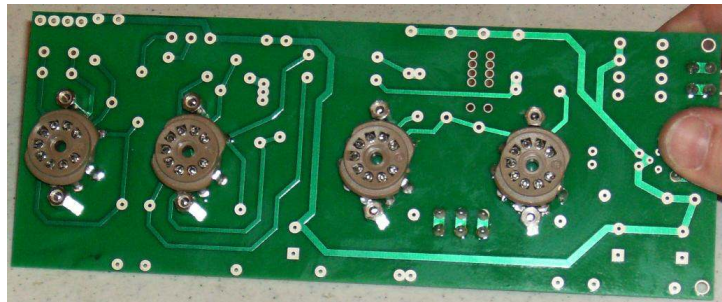

7.1.4 The Power Grid

Install the four (4) rectifier diodes. Orient the diodes as indicated on the circuit board. Bend the leads over, insert them into the board, and bend them to the side as shown. Solder them to the board.

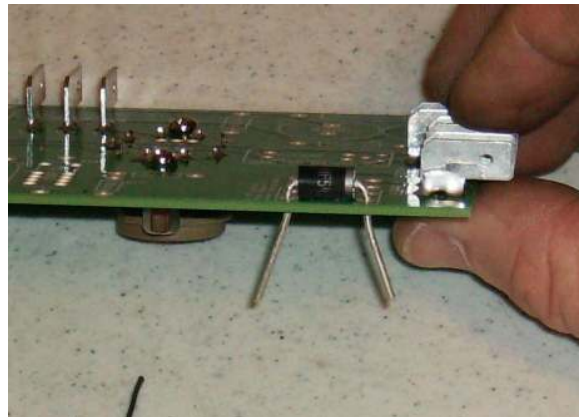

Trim the leads off at the top of each solder pool.

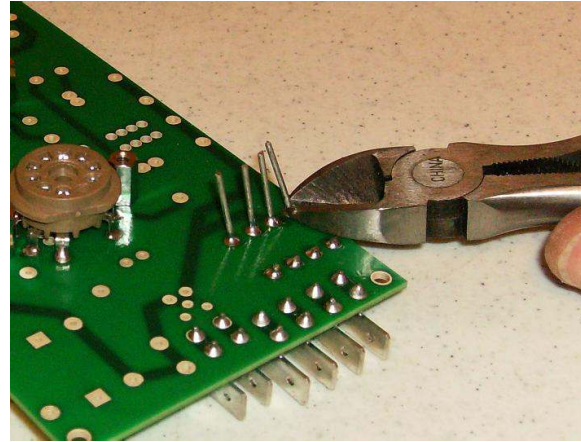

Install, solder and trim all of the resistors in the power grid as shown. Refer to the latest version of the schematic on GuitarAmplifierPCBs.com, the Baby Will circuit board, and the component package to identify, locate and position component values.

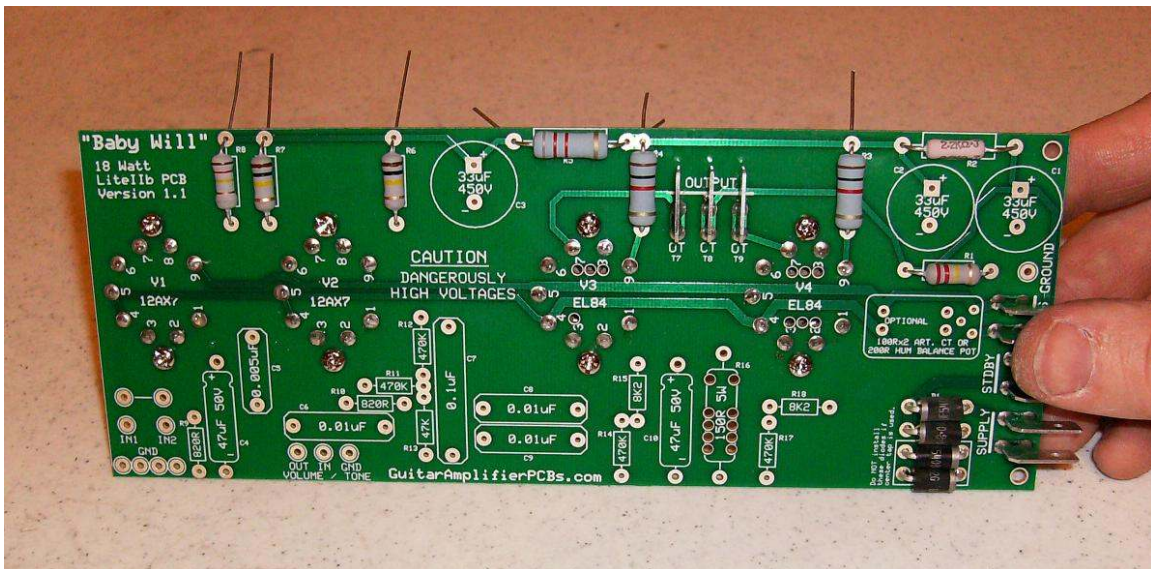

The filtering capacitors are not installed at this time. The height of these capacitors interferes with the installation of the other components. These capacitors will be the last component installed.

7.1.5 *Signal Path and Cathode Resistors*

Install, solder and trim all of the signal path and cathode resistors as shown.

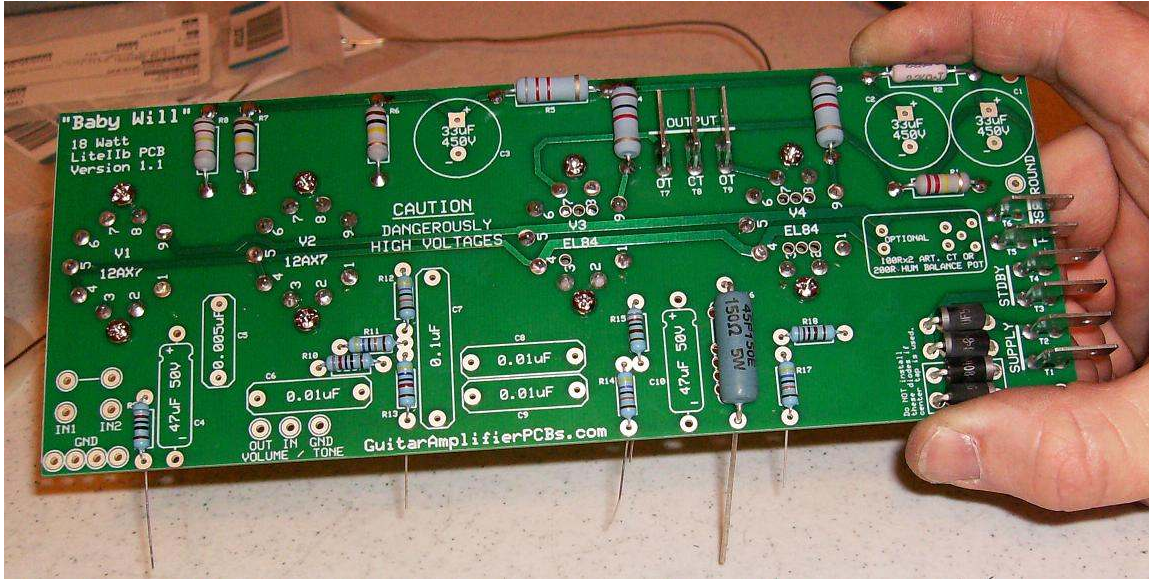

Don't bother with the input section. We'll get to that later.

7.1.6 *Signal Path and Cathode Capacitors*

Install, solder and trim all of the signal path and cathode capacitors as shown. Make sure the 47uF cathode bypass capacitors are oriented with the polarities indicated on the circuit board.

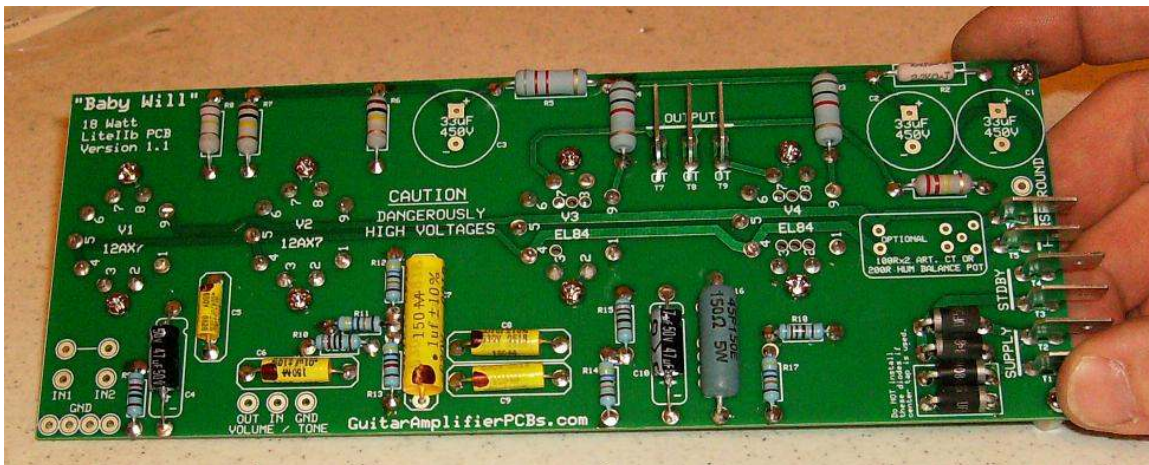

7.1.7 Hum Balance Options

This section describes the options you can use to reduce any noise or hum induced by the tube heater element supply.

Version 1.1 provides for the following configurations:

- An artificial center tap tied to ground, or
- A hum balance potentiometer with its wiper tied to ground.

Version 1.3 provides the following options:

- An artificial center tap tied to ground, or
- A hum balance potentiometer with its wiper tied to ground, or
- A DC elevated artificial center tap tied to the cathode of the power tubes, or
- A DC elevated hum balance potentiometer with its wiper tied to ground the cathode of the power tubes.

The hum balance potentiometer is the recommended option for both versions of the board. Version 1.1 users should install the pot with the wiper tied to ground (it's the only way). Version 1.3 users should install the pot with the wiper tied to the power tubes' cathode to use the DC elevated bias. Both installations are described and illustrated below.

The hum balance pot is a 200 ohm 10 turn trimmer potentiometer. Its purpose is to neutralize any transient noise, or unbalance, in the heater element supply voltage.

Hum Balance Pot – Tied to Ground

Install the hum balance pot in the area circled.



Before installing the pot, balance the resistance on each side to roughly 100 ohms. This is useful later when you have to dial the buzz out of the heater supply voltage.

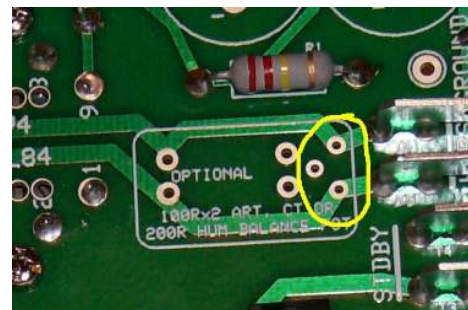

Clip the black lead from your ohmmeter to the center post on the pot. Clip the red lead to one of the outer posts. Adjust the screw on the pot until you ohmmeter read 100-110 ohms. No need to measure the other side. It should be close to the same resistance.

Insert the pot, solder, and trim the leads.



It can only be installed in one direction so don't worry about that.

Hum Balance Pot – DC Elevated

Version 1.3 is equipped with the option to elevate the artificial center tap or the hum balance pot by using the cathode lead, pin 3, from the EL84 power tubes.

Here's a picture of the area where this option is located.

Sorry, but we couldn't add the silkscreen component graphics since multiple parts are located in the same area.

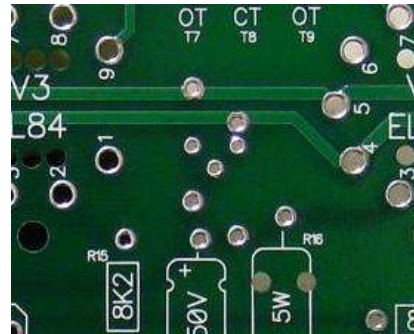

This is how you can install a DC Elevated Hum Balance Pot.

Install the pot in the location highlighted. Again, the pot will only fit in one direction.

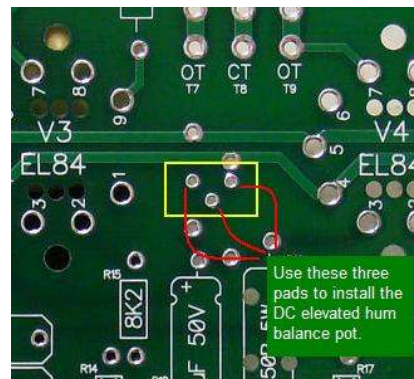

7.1.8 Filter Capacitors and Ground Wire

We can install the filter caps now that we have most of the components installed on the board.

Insert the three (3) filter capacitors in their locations as indicated on the board.



These capacitors are polarized. Be careful to install them by inserting the positive lead (the longer one) into the square pad and the negative lead (as indicated by the downward arrow and “-“ symbol) in the round pad.

Insert the ground wire that was removed from the stock EVJ circuit board in the ground pad indicated on the Baby Will circuit board.

Solder and trim the leads.

7.1.9 Input Jack and 1Meg Resistor (for Version 1.1)

The input section of the Baby Will is designed to accommodate a variety of configurations. The VJ Conversion only calls for one input jack. This requires a jumper to tie the two input leads together so the two halves of V1 (12AX7) work in parallel. Because the 1M ohm resistor is typically installed on the input jack and we are using the stock EVJ jack, we will have to improvise and install this resistor on the board. Lucky for us the board was design with enough flexibility to accommodate.

Insert the resistor in the jumper stage of Input #2 and a ground pad as shown.

Insert a jumper wire in the jumper stage across Input #1 and #2. This ties the inputs together and creates the parallel V1 preamp configuration.

Solder and trim the leads.

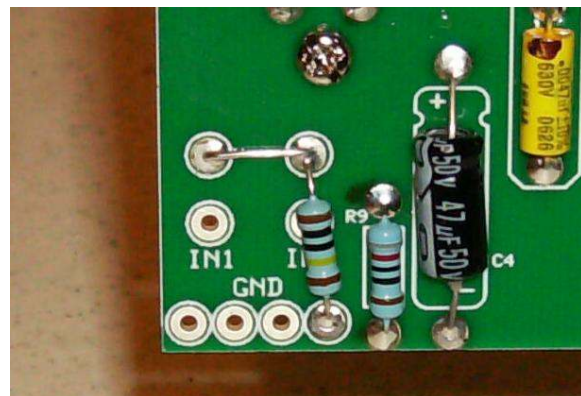

Here's how to hookup the input for a single input. This only uses 1/2 of the 12AX7, so the preamp will output less gain. This will give you a little bit more headroom. But you still get the crunch. You just have to turn it up a point or two.

Insert the resistor in the jumper stage of Input #1 and ground pad.



Do not install the jumper across the inputs for a single input configuration.

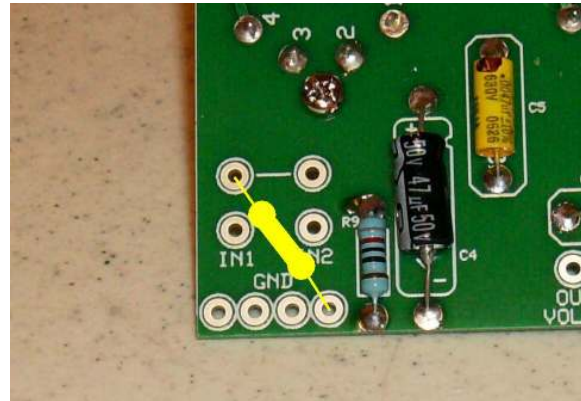

Prepare the stock input jack by cutting off the stock connector.



Cut off the connector that plugged into the stock EVJ circuit board. Leave the input connector plugged into the input jack board.



Strip the insulation from the leads.

Insert the white lead into the Input #1 pad and the black lead into a ground pad. Solder and trim.

The input section is done.

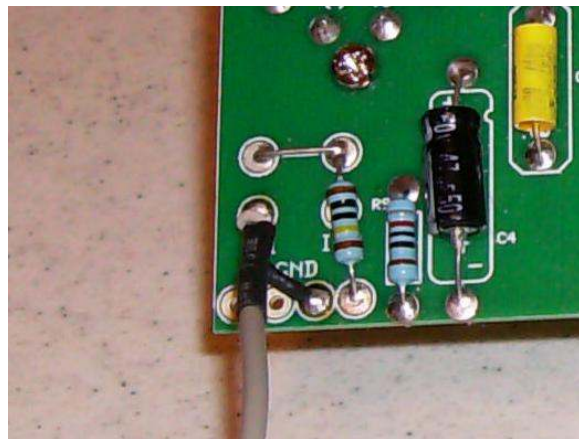

7.1.10 Input Jack and 1Meg Resistor (for Version 1.3)

The input section of the Baby Will is designed to accommodate a variety of configurations. The VJ Conversion only calls for one input jack. This requires a jumper to tie the two input leads together so the two halves of V1 (12AX7) work in parallel. Version 1.3 provides for the installation of all of the input components, minus the input jack, on the circuit board. A 10Kohm resistor was inserted inline with the signal to block any radio signal interference.

Insert the 10K and 1Meg resistors in the locations shown (and labeled on the board).

Insert a jumper wire in the jumper stage across Input #1 and #2. This ties the inputs together and creates the parallel V1 preamp configuration.

Solder and trim the leads.

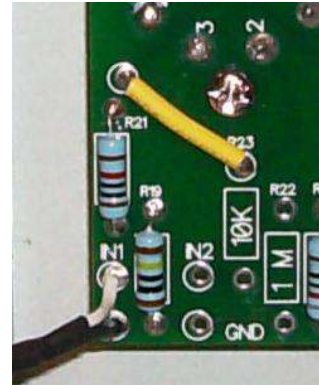

If you don't want to run the preamp tube in parallel, do not install the jumper wire. This will only use ½ of the 12AX7, so the preamp will output less gain. This will give you a little bit more headroom. But you still get the crunch. You just have to turn it up a point or two.



A cool modification is to install a switch in between this jumper so you can switch from single to parallel operation.

Prepare the stock input jack by cutting off the stock connector.



Cut off the connector that plugged into the stock EVJ circuit board. Leave the input connector plugged into the input jack board.

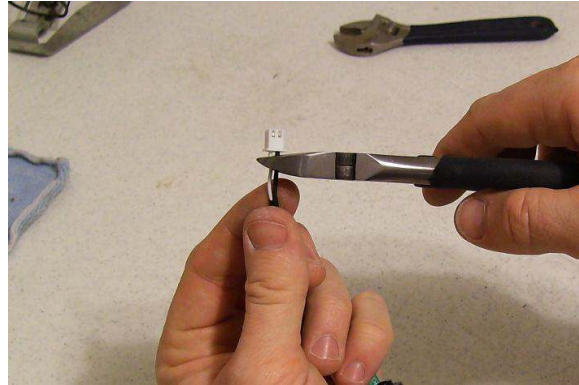

Strip the insulation from the leads.

Insert the white lead into the input #1 ("IN1") pad and the black lead into a ground pad. Solder and trim.

The input section is done.

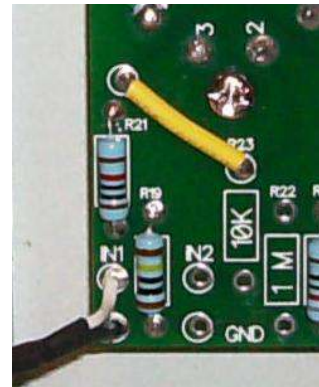

Here's what everything should look like so far (minus the input jack wiring).

Version 1.1

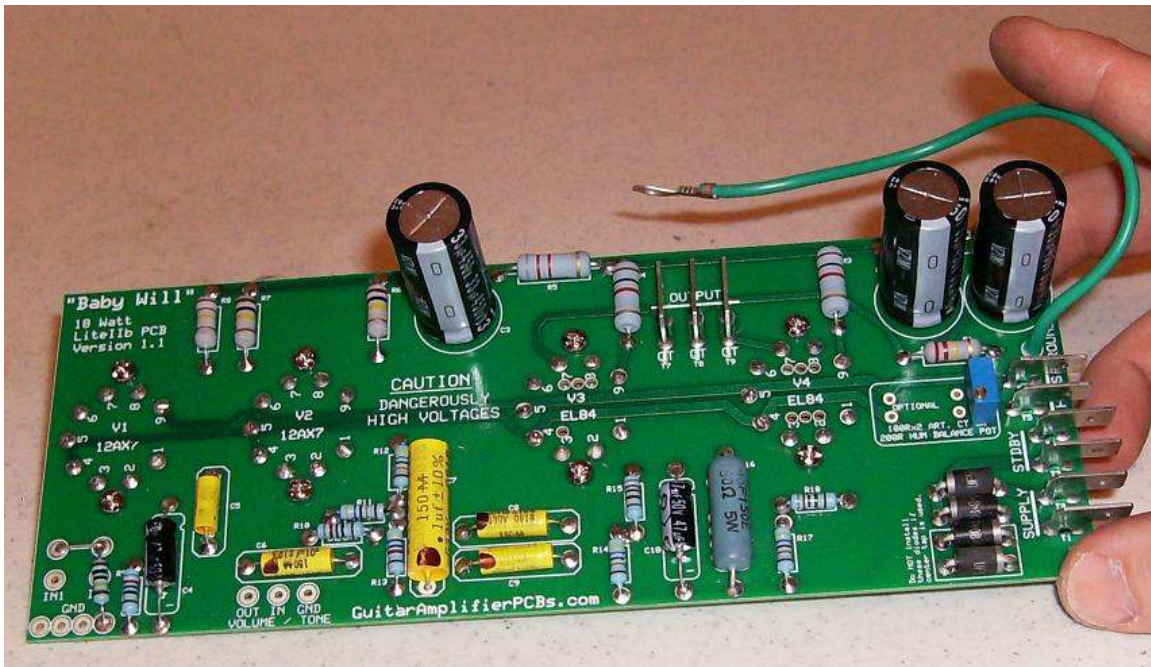

Version 1.3

(Oops, this picture is missing the ground wire.)



7.1.11 Volume and Tone Controls

To better understand how the volume and tone controls are wired, we recommend that you study the VJ Conversion Chassis Layout and Schematic.

Cut the tab off of each of the pots with a pair of cutters (side cuts). A pair of pliers can also be used to bend the tab over and break it off.



We like to install the controls on the outside of the chassis for better access.



Be careful with the soldering iron if you temporarily install the pots on the outside of the chassis. Fluxed solder will spit and spatter onto the face of the chassis.



Here's a picture of how the controls are configured. Sorry, the picture doesn't help much. It's not the best work we've done.

The best resource is the layout diagram.

The volume and tone controls are connected to the Baby Will circuit board by flying leads.

Remove the controls from the chassis and install the leads in the board.

Solder and trim the leads.

Here's what it all should look like. It's now ready to be installed in the chassis.

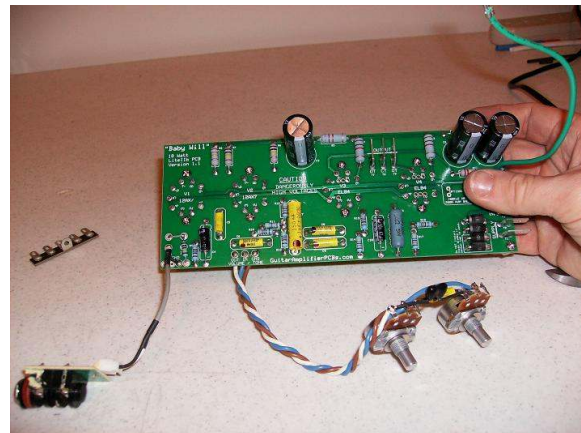

8. Putting it All Together

8.1 Install the New Components

Now that everything is out of the chassis that we don't need, the chassis has been drilled, and the Baby Will has been assembled, we can prep the chassis and install all of the new components.

8.1.1 The New Output Transformer

Relocate the extra power transformer grommet from the left-front to the new hole drilled for the output transformer.



Guide the leads through the grommets and seat the output transformer in place. Position the output transformer with its primary to the front and secondary to the back as shown.



Guide all of the wires through the chassis.
(Learn from our mistakes.)



The extra wires will be secured and stowed inside the chassis. Their location outside the chassis is too susceptible to the heat from the tubes.

Secure the output transformer to the chassis using the stock fasteners.

Cut and solder the output transformer leads onto the output jack board.



Refer to the GuitarAmplifierPCBs.com layout diagram, transformer hookup diagram, and output jack board for hookup details.

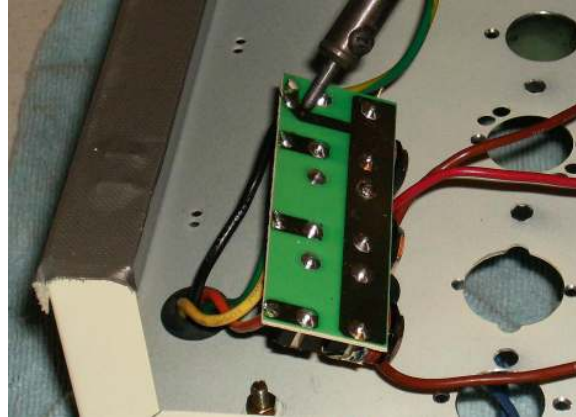

Re-Install the output jack board into its stock location.

Guide the ground wire from the output jack board to the star grounding stud.

This will be secured to the stud later.

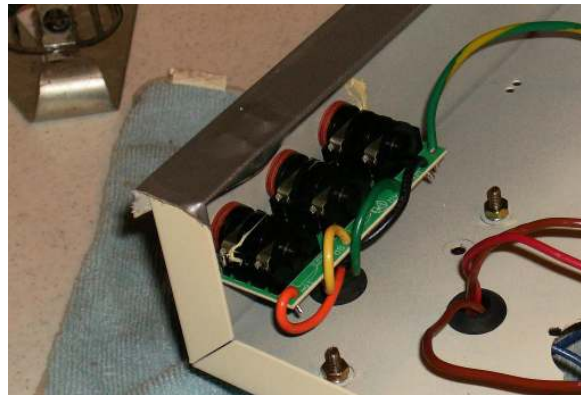

8.1.2 *The Baby Will PCB and Tube Hardware*

Lay the Baby Will down into the EVJ chassis with the tube sockets toward the chassis and the diodes toward the power rocker switch. Align the standoffs with their respective holes and fasten a screw into the standoff(s) near the power transformer.



Do not tighten them down. The board still needs to be aligned with the tube holes and tube hardware.

Position the tube hardware on the top of the chassis. Align the hardware with their respective holes and fasten with a screw.

Install and fasten the volume and tone controls and the input jack into the chassis. Slide the volume and tone knobs onto the pot stems and fasten with the set screw.

It should look like this when you're done.



Here's a closer look at the controls.



8.1.3 Hookup the Leads to the Baby Will

The board is installed in the chassis, but we still need to hook the high voltage supply, heater element supply, output transformer, and the sag resistor.

Install a tag strip to the transformer screw posts. Guide the leads of the power resistor (sag resistor) through the outer two tabs. Wire a lead from these tabs to the two “Standby” spade connectors (T3 and T4) on the Baby Will.

It should look like this when you’re done.



Slide the stock EVJ high voltage supply leads onto the Baby Will spade connectors (T1 and T2) as shown.

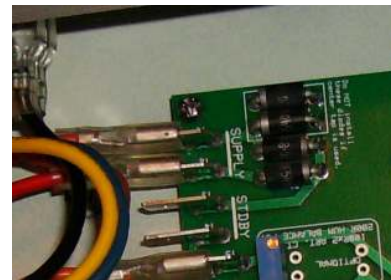

Slide the stock EVJ heater element voltage supply leads (orange) onto the Baby Will spade connectors (T5 and T6) as shown.



Slide the new ¼ - 32 spade connectors from the 8K primary output transformer leads onto the Baby Will spade connectors as shown.

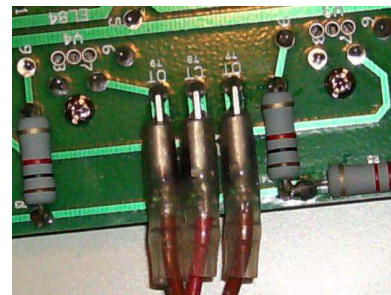

The middle terminal (T8) is the center tap and the two outer terminals (T7 and T9) are the output signal leads.

Fasten the ground wires from the Baby Will circuit board and the output transformer to the star ground screw post.

Here's how it should look when everything is hooked up.

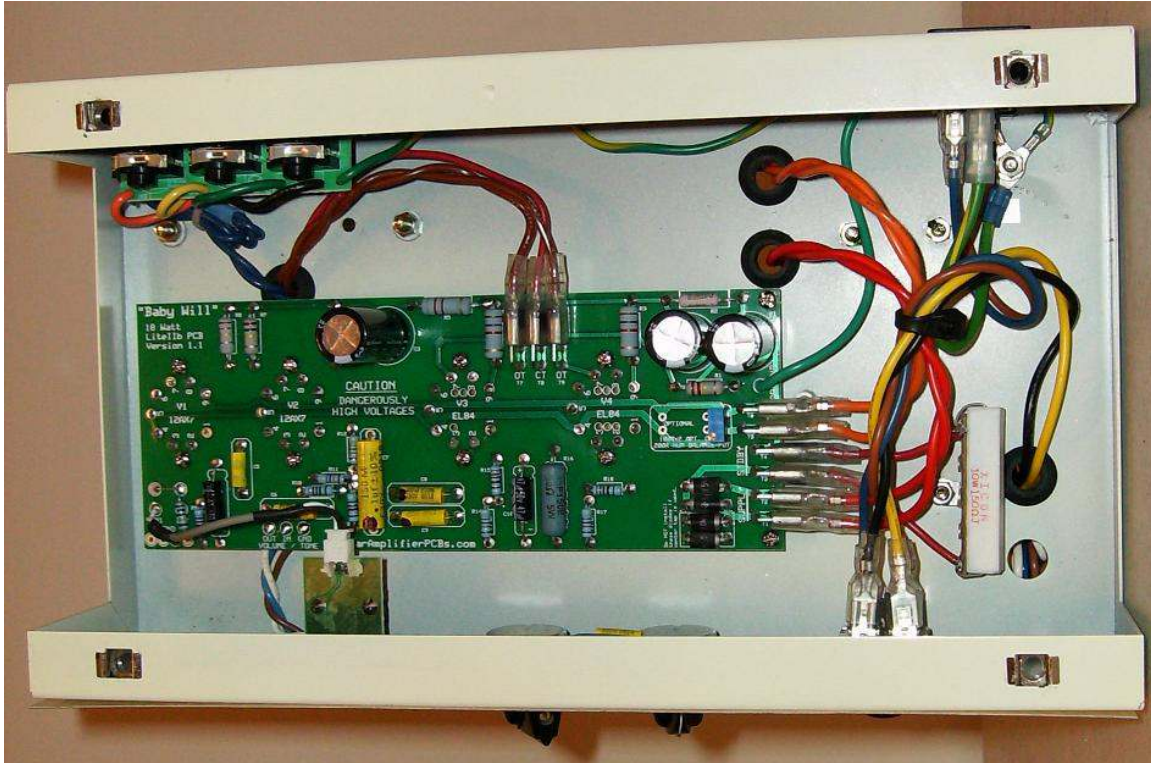

Good Job!

You're almost done. But, before you start celebrating, you still have to review your work, start it up and test the voltages.

9. Turn on the Power

9.1 Check Your Work

9.1.1 Take a Break

Now is a good time to take break. Rest your mind and gather your thoughts. You don't want to be tired or rushed while performing the following steps.

9.1.2 Visual Inspection

When you are ready, step through the instructions in this manual again and verify each step was performed and completed properly.

Look for the following:

- Missing components
- Damaged components or leads
- Solder joints that may have spilled over onto a nearby component or solder pad.
- Loose connections.
- Stray bits of wire from trimming wire and/or components.
- Components or wire leads shorting against each other or the chassis.



Pay special attention to the volume and tone controls and the sag resistor.

- Check that the IEC mains power connector is equipped with a good fuse. The fuse should be rated for 2A Slo-Blo.
- Check that the heater element supply (orange wires) is equipped with a good fuse. The fuse should be rated for no more than 4A Slo-Blo.

9.2 Power Up without Tubes

9.2.1 *The First Power Up*



Make sure you are working in a safe area free of any flammable chemicals or vapors. An assembly error may result in the emission of sparks.



The tubes should NOT be installed during the initial power up.



These measurements will NOT match those on the schematic. These are “As-Built” measurements. The actual voltages will be measured after the tubes are installed and the circuit draws current.

Verify the amp’s power switch is in the “Off” position. Insert the mains power cord in the IEC mains connector.

Secure the black ground lead of your voltmeter to the chassis star ground lug.

Switch the amp’s power switch to the “On” position. With your AC voltmeter, check the following AC voltages. If a significant deviation from these readings is observed, turn off the amp, unplug the mains power and investigate.

T1 and T2 should read ~ 129Vac.

Measured Voltage _____

Comments _____



T5 and T6 should read ~ 3.5 to ~ 2.5Vac depending on how well you centered the hum balance pot. The sum of these voltages should equal ~ 6.1 Vac.

Measured Voltage _____

Comments _____



Switch your voltmeter to read DC voltage.

T3 and T4 should read ~ 393 Vdc.

Measured Voltage _____

Comments _____



Pin 1 of V1 should read ~ 388 Vdc.

Measured Voltage _____

Comments _____

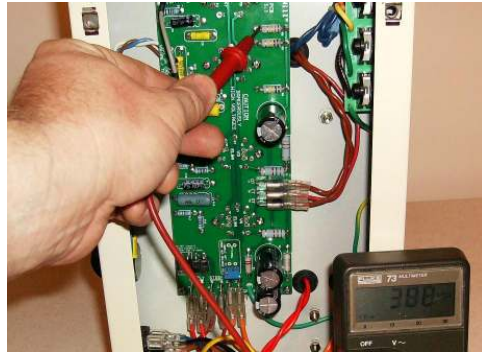

9.3 Power Up with Tubes

9.3.1 *The Real Test*



Install the tubes! Aren't they pretty?



These measurements WILL match those on the schematic.

Verify the amp's power switch is in the "Off" position. Insert the mains power cord in the IEC mains connector.

Secure the black ground lead of your voltmeter to the chassis star ground lug.



Plug the amplifier into a speaker cabinet. Match the speaker impedance with the appropriate output jack. Failure to connect a speaker will cause harm and eventual failure of the output transformer.

Switch the amp's power switch to the "On" position. With your voltmeter, check the following DC voltages. If a significant deviation from these readings is observed, turn off the amp, unplug the mains power and investigate.

T3 should read ~ 334 Vdc

Measured Voltage _____

Comments _____



T4 should read ~ 322 Vdc

Measured Voltage _____

Comments _____



After R2 (2.2 K Ω) ~ 300 Vdc

Measured Voltage _____

Comments _____



After R5 (8.2 K Ω) ~ 279 Vdc

Measured Voltage _____

Comments _____



After R8 (120 K Ω) ~ 134 Vdc

Measured Voltage _____

Comments _____



After R7 (100 K Ω) ~ 212 Vdc

Measured Voltage _____

Comments _____

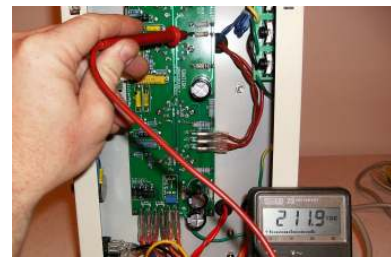

After R6 (100 K Ω) ~ 217 Vdc

Measured Voltage _____

Comments _____

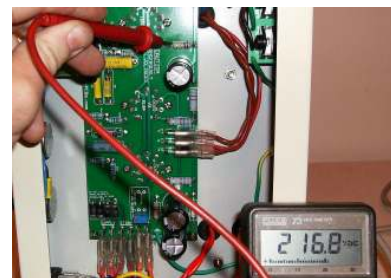

After R4 (1 K Ω) ~ 299 Vdc

Measured Voltage _____

Comments _____



After R3 (1 K Ω) ~ 301 Vdc

Measured Voltage _____

Comments _____



Pin 3 of V3 and V4 ~ 10.09 Vdc

Measured Voltage _____

Comments _____

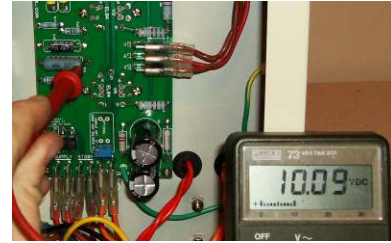

Pins 3 and 8 of V1 ~ 1.02 Vdc

Measured Voltage _____

Comments _____



10. Dial Out the Buzz

10.1 Adjusting the Hum Balance Potentiometer

The hum balance potentiometer is a 200Ω 10 turn trimmer pot used to balance the transient noise riding on the heater element power supply.

10.1.1 Procedure (for Verion 1.1)

1. Nothing should be plugged into the input(s),
2. Tone control dialed to high treble (almost dimed),
3. Volume control dialed to 8 or 9 (dimed is fine too),
4. Clip the black ground lead on your voltmeter to the chassis star ground lug,
5. Using a voltmeter, measure the AC voltage on each side of the balance pot,
6. Measure the voltage by probing the component pad (hole) by the pot in each trace,



Hopefully, the voltage is nearly equal on both sides. This does not mean the supply is balanced. Transient "noise" rides on the supply and needs to be "balanced".



7. Using a non-conductive screw driver, rotate the trimmer screw two full turns listening for a trend in the buzz. If the buzz increases, stop and change directions. If the buzz decreases, you are moving in the right direction.
8. Stop and measure the voltage again, as described in step #6, making sure you are not approaching less than 1 volt AC on either side.
9. Typically, the heater supply will balance at 1.6 - 2.7 Vac one side and 4.5 - 3.4 Vac the other side.
10. This procedure should reduce any buzz/hum noise to an inaudible level.

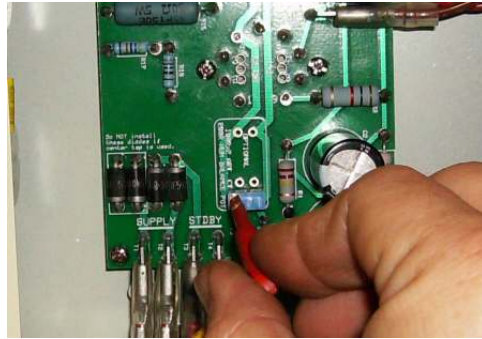

10.1.2 Procedure (for Verion 1.3)

No need to worry about shorting the hum balance pot to ground if you installed it in the DC elevated location. So you don't need to monitor the voltages with your voltmeter. All you have to do is simply turn the dial until the lowest level of noise is reached. Or, you can do this...

1. Nothing should be plugged into the input(s),
2. Tone control dialed to high treble (almost dimed),
3. Volume control dialed to 8 or 9 (dimed is fine too),
4. Using a non-conductive screw driver, rotate the trimmer screw two full turns listening for a trend in the buzz. If the buzz increases, stop and change directions. If the buzz decreases, you are moving in the right direction.
5. This procedure should reduce any buzz/hum noise to an inaudible level.

A very low hum (ear against the speaker low) has been experienced in some development amps. However, this was attributed to unmatched power tubes. Also, if a hum persists, we recommend you investigate how the heater supply leads are routed in the chassis (lead dress).

11. Finish Things Up

11.1 Re-Assemble the Amp

Slide the chassis back into the stock cabinet.
Fasten the chassis to the cabinet with the stock screws.
Insert the screw caps into the sockets.
Press them in until they are flush with the cabinet surface.
Attach the back panel with the stock screws.

Congratulations! Your Valve Junior is complete. Plug in a guitar and enjoy the legendary tone of your 18 Watt Litellb “Baby Will” guitar amplifier.